

Tree 1 Rowland Main Tree

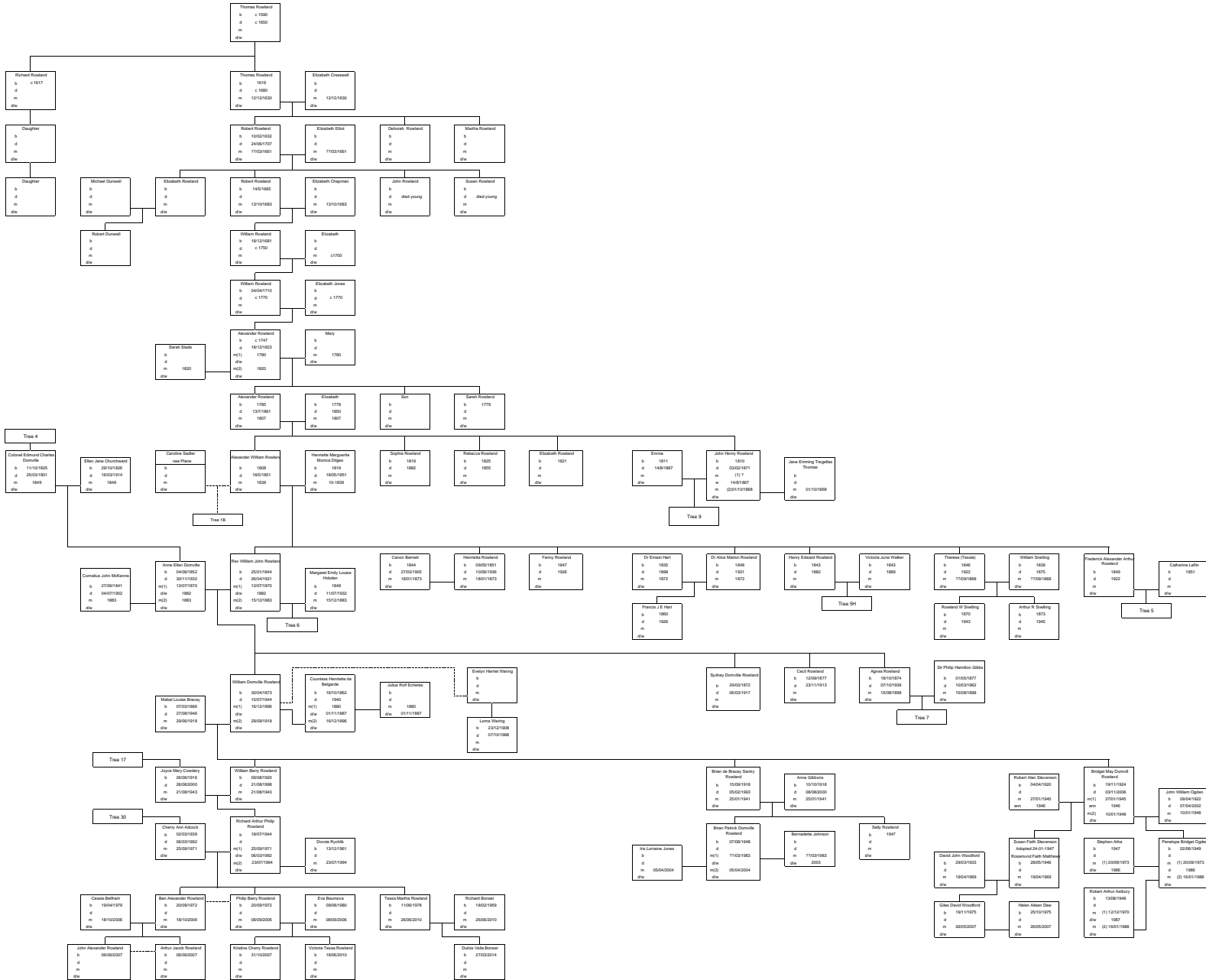

Rowland Family Tree

Name	Year of Birth or c	Estimated first year of decade
Adcock Cherry Ann	1939	
Aitbury Robert Arthur	1948	
Alha Stephen	1946	
Barnett Canon	1844	
Baumova Eva	1980	
Belgarde Countess Henriette de	1862	
Belham Cassie	1978	
Bonsar Richard	1959	
Bracey Mabel Louisa	1886	
Chapman Elizabeth	c 1860	
Churchward Ellen Jane	c 1820	
Cowdery Joyce Mary	1916	
Cresswell Elizabeth	c 1810	
Daw Helen Aileen	1975	
Dilges Henriette Marguerite Monica von	1819	
Domville Anne Ellen	1852	
Domville Colonel	1825	
Dunwell Michael	c 1860	
Dunwell Robert	c 1880	
Elliott Elizabeth	c 1830	
Gibbons Anne	1918	
Gibbs Philip Hamilton (Sir)	1877	
Hart Ernest (Dr)	c 1840	
Hobden Margaret Emily Louise	1849	
Johnson Bernadette	c 1840	
Jones Elizabeth	c 1710	
Jones Iris Lorraine	c 1840	
Matthews Rosamund Faith	1946	
McKenna Captain	c 1850	
Ogden John William	1922	
Ogden Penelope Bridget	1949	
Rowland Agnes	1874	
Rowland Alexander	1869	
Rowland Alexander	1747	
Rowland Alexander	1785	
Rowland Alexander William	1808	
Rowland Alice	1871	
Rowland Alice	1848	
Rowland Arthur Jacob	2007	
Rowland Ben Alexander	1972	
Rowland Brian de Bracey Santry	1918	
Rowland Brian Patrick Domville	1948	
Rowland Bridget May Dumvill	1924	
Rowland Cicil	1877	
Rowland Deborah	c 1830	
Rowland Edith	1867	
Rowland Elizabeth	c 1860	
Rowland Elizabeth	1821	
Rowland Fanny	1847	
Rowland Flossi	1874	
Rowland Frederick Alexander Arthur	1849	
Rowland Henriette	1851	
Rowland Henry Edward	1843	
Rowland John	c 1860	
Rowland John Alexander	2007	
Rowland John Henry	1810	
Rowland Kristina Cherry	2007	
Rowland Martha	c 1830	
Rowland Philip Barry	1972	
Rowland Rebecca	1825	
Rowland Richard	c 1817	
Rowland Richard Arthur Philip	1944	
Rowland Robert	1832	
Rowland Robert	1865	
Rowland Sally	1947	
Rowland Sarah	1779	
Rowland Sophia	1819	
Rowland Susan	c 1860	
Rowland Sydney Domville	1872	
Rowland Tessa Martha	1978	
Rowland Thomas	c 1890	
Rowland Thomas	1819	
Rowland Victoria Tessa	2010	
Rowland Walter	1876	
Rowland William	1881	
Rowland William	1710	
Rowland William Barry	1920	
Rowland William Domville	1873	
Rowland William John (Rev)	1844	
Rychik Dorota	1961	
Slade Sarah	c 1740	
Snelling Arthur	1873	
Snelling Rowland	1870	
Snelling William	c 1840	
Stevenson Robert Alan	1905	
Stevenson Susan Faith	1946	
Thomas Jane Emming Tregellas	c 1810	
Waring Evelyn Harriet	c 1870	
Waring Lorna	1908	
Woodford David John	1933	
Woodford Giles David	1975	
Catherine	1851	
Elizabeth	1778	
Elizabeth	c 1880	
Emma	1811	
Mary	c 1740	
Theresa (Tessie)	1846	
Victoria June	c 1840	

Name	Year of Birth or c	Estimated first year of decade
Rowland Thomas	c 1890	
Cresswell Elizabeth	c 1810	
Rowland Richard	c 1817	
Rowland Thomas	1819	
Elliott Elizabeth	c 1830	
Rowland Deborah	c 1830	
Rowland Maria	c 1830	
Rowland Robert	1832	
Chapman Elizabeth	c 1860	
Dunwell Michael	c 1860	
Rowland John	c 1860	
Rowland Susan	c 1860	
Rowland Robert	1865	
Dunwell Robert	c 1880	
Elizabeth	c 1880	
Rowland William	1881	
Jones Elizabeth	c 1710	
Rowland William	1710	
Slade Sarah	c 1740	
Mary	c 1740	
Rowland Alexander	1747	
Elizabeth	1778	
Rowland Sarah	1779	
Rowland Alexander	1785	
Rowland Alexander William	1808	
Rowland John Henry	1810	
Thomas Jane Emming Tregellas	c 1810	
Emma	1811	
Dilges Henriette Marguerite Monica von	1819	
Rowland Sophia	1819	
Churchward Ellen Jane	c 1820	
Rowland Elizabeth	1821	
Domville Colonel	1825	
Rowland Rebecca	1825	
Hart Ernest (Dr)	c 1840	
Snelling William	c 1840	
Victoria June	c 1840	
Rowland Henry Edward	1843	
Barnett Canon	1844	
Rowland William John (Rev)	1844	
Theresa (Tessie)	1846	
Rowland Fanny	1847	
Rowland Alice	1848	
Hobden Margaret Emily Louise	1849	
Rowland Frederick Alexander Arthur	1849	
McKenna Captain	c 1850	
Rowland Henriette	1851	
Catherine	1851	
Domville Anne Ellen	1852	
Belgarde Countess Henriette de	1862	
Rowland Edith	1867	
Rowland Alexander	1869	
Snelling Rowland	1870	
Waring Evelyn Harriet	c 1870	
Rowland Alice	1871	
Rowland Sydney Domville	1872	
Rowland William Domville	1873	
Snelling Arthur	1873	
Rowland Agnes	1874	
Rowland Flossi	1874	
Rowland Walter	1876	
Gibbs Philip Hamilton (Sir)	1877	
Rowland Cicil	1877	
Bracey Mabel Louisa	1886	
Stevenson Robert Alan	1905	
Waring Lorna	1908	
Cowdery Joyce Mary	1916	
Gibbons Anne	1918	
Rowland Brian de Bracey Santry	1918	
Rowland William Barry	1920	
Ogden John William	1922	
Rowland Bridget May Dumvill	1924	
Woodford David John	1933	
Adcock Cherry Ann	1939	
Johnson Bernadette	c 1840	
Jones Iris Lorraine	c 1840	
Richard Arthur Philip	1944	
John Stigmen	1946	
Matthews Rosamund Faith	1946	
Stevenson Susan Faith	1946	
Rowland Sally	1947	
Aitbury Robert Arthur	1948	
Rowland Brian Patrick Domville	1948	
Ogden Penelope Bridget	1949	
Bonsar Richard	1959	
Rychik Dorota	1961	
Rowland Ben Alexander	1972	
Rowland Philip Barry	1972	
Daw Helen Aileen	1975	
Woodford Giles David	1975	
Rowland Tessa Martha	1978	
Belham Cassie	1979	
Baumova Eva	1980	
Rowland Arthur Jacob	2007	
Rowland John Alexander	2007	
Rowland Kristina Cherry	2007	
Rowland Victoria Tessa	2010	

Tree 1B Sadler Tree

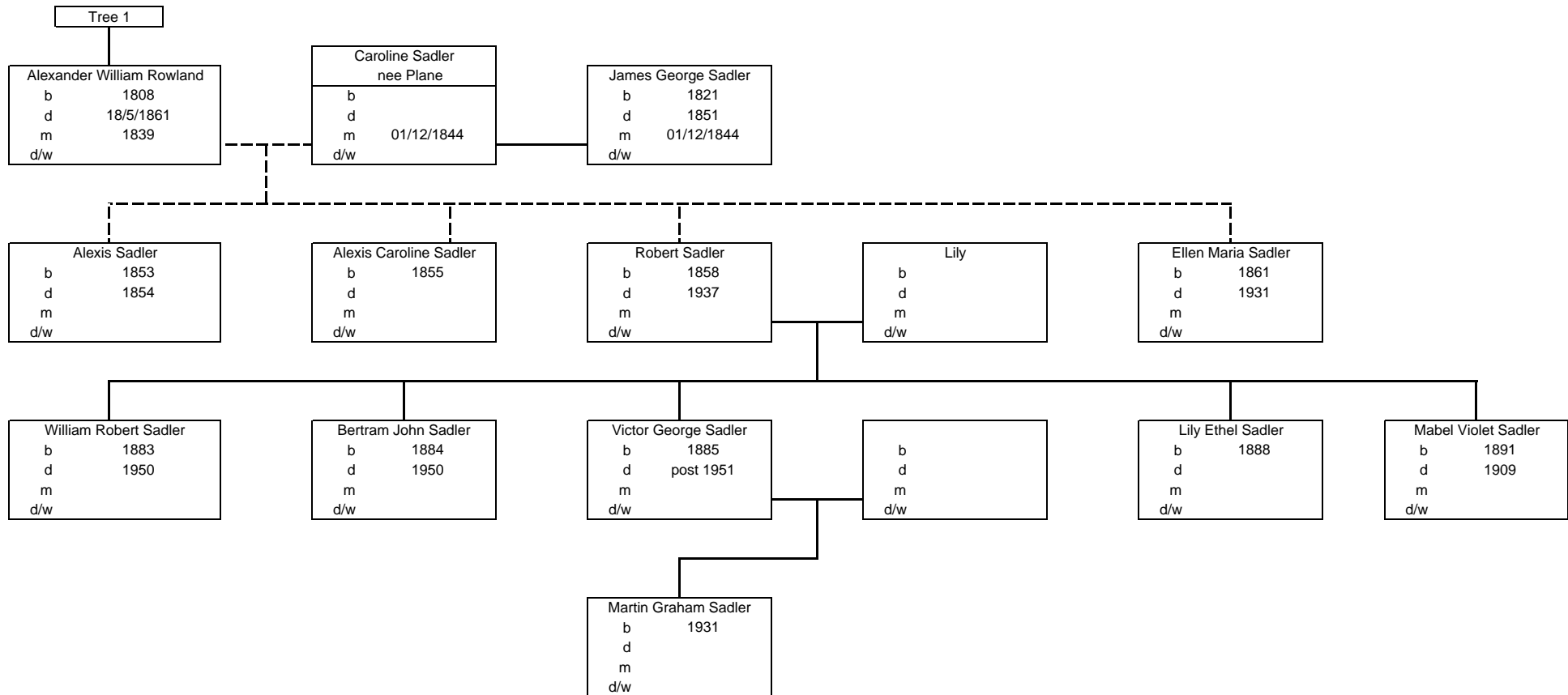

Tree 2
"London" Rowland Male Line

Tree 3
"Sussex" Rowland Male Line

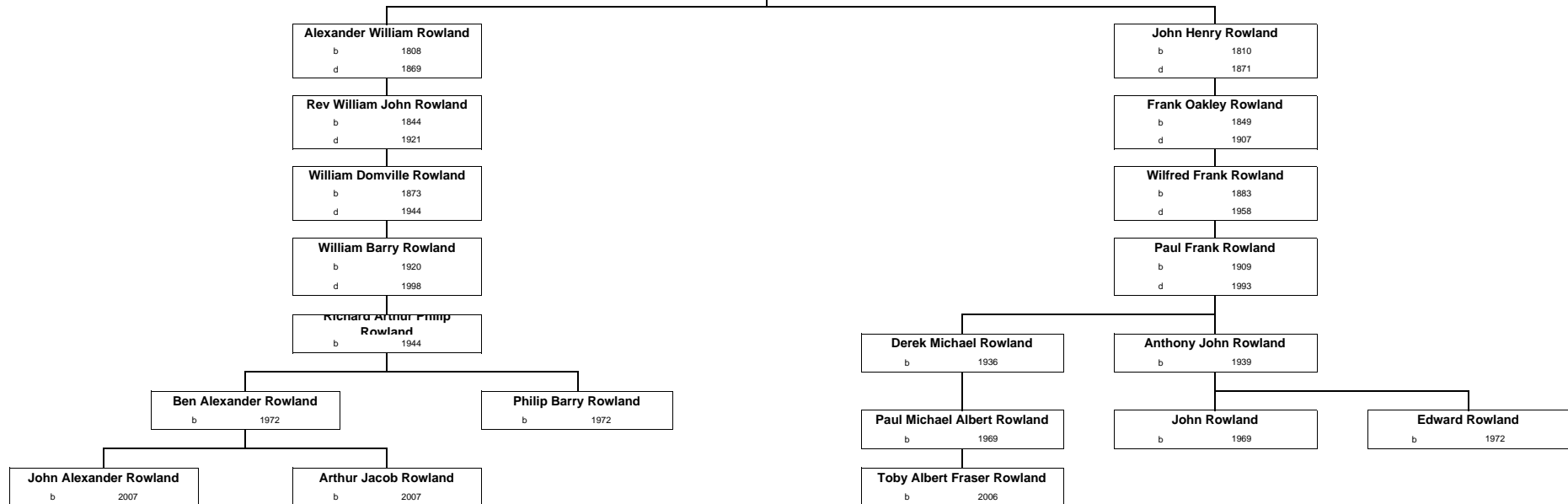
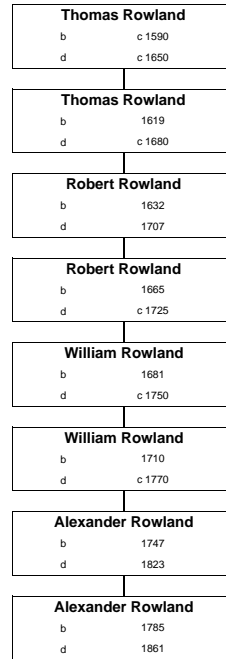

Tree 4 Domville Tree

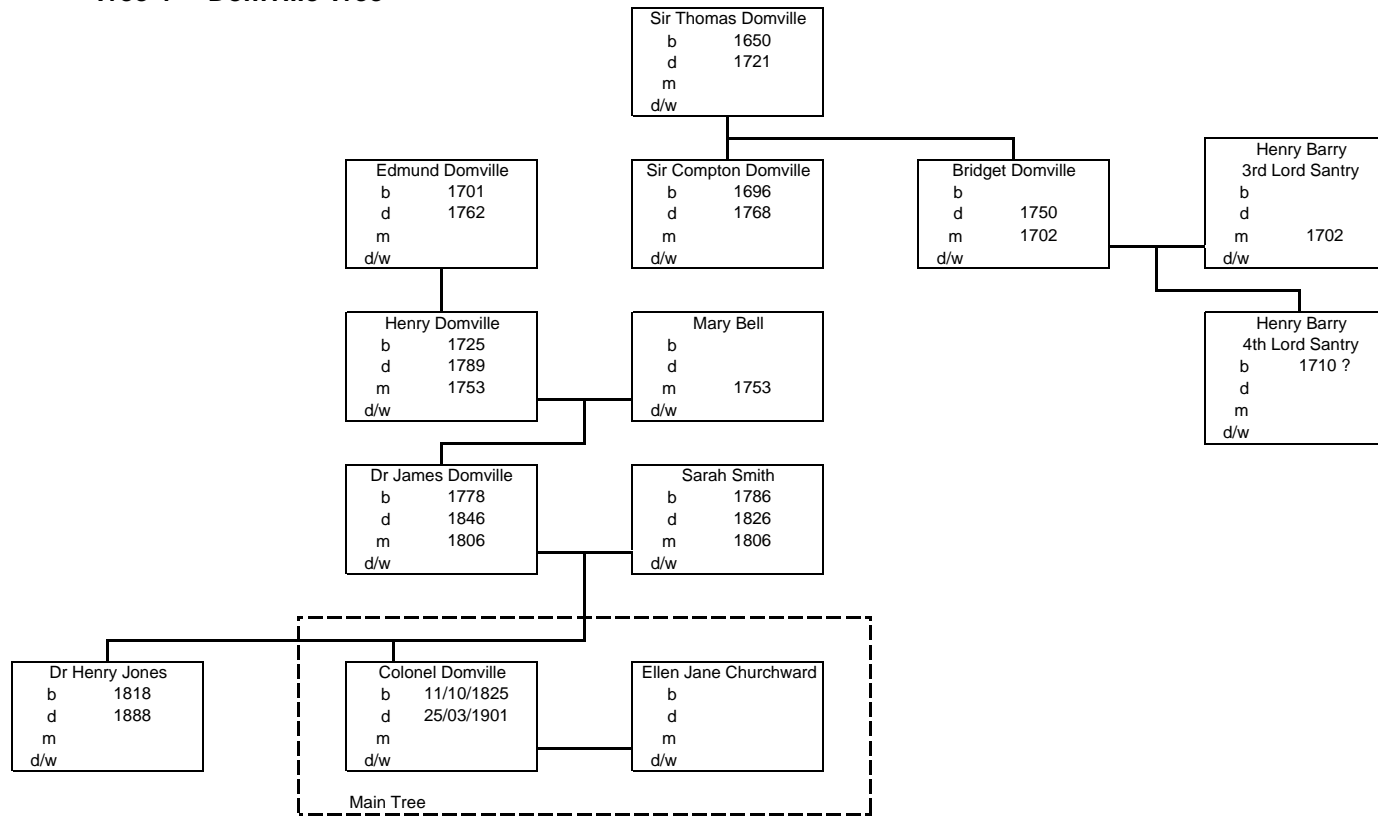

Tree 5

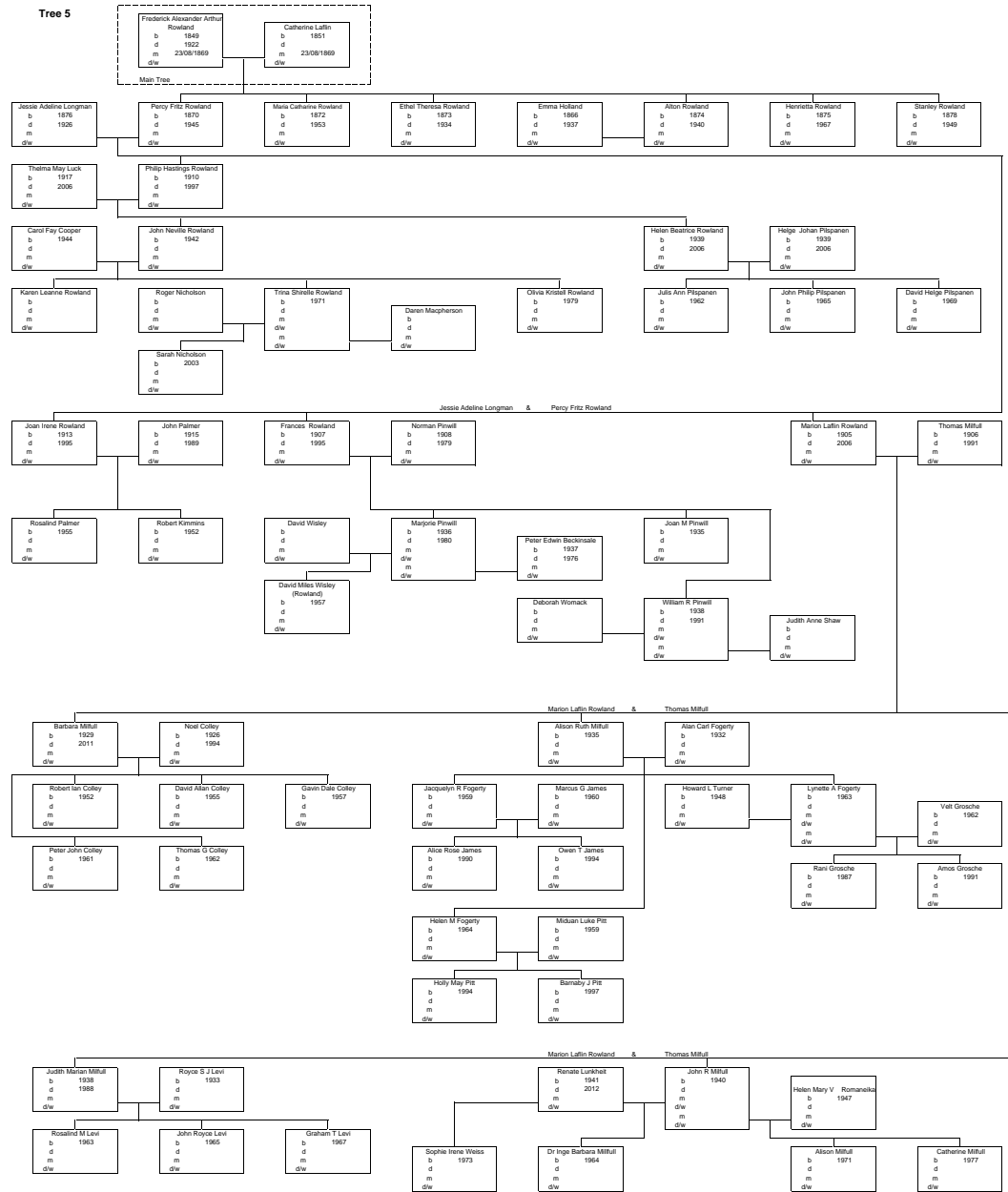

Tree 5H

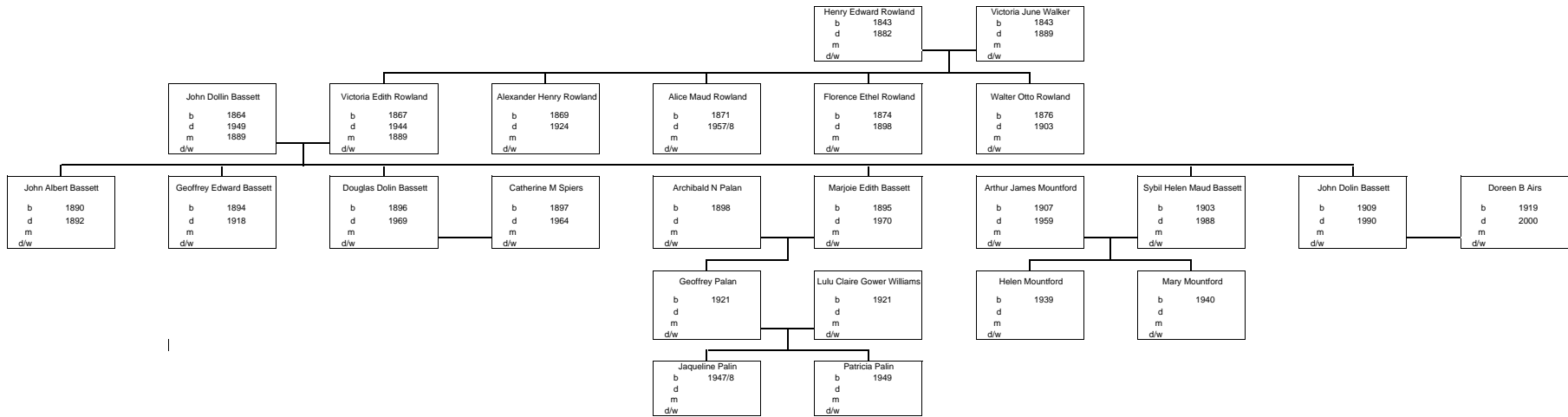

Tree 6 Hobden / Harbottle Reed Tree

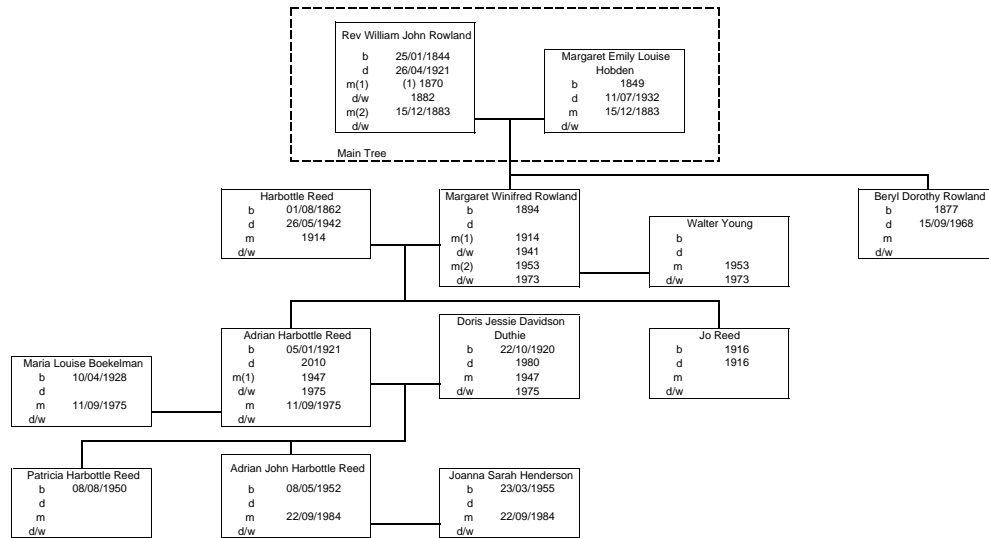

Tree 7 Gibbs Tree

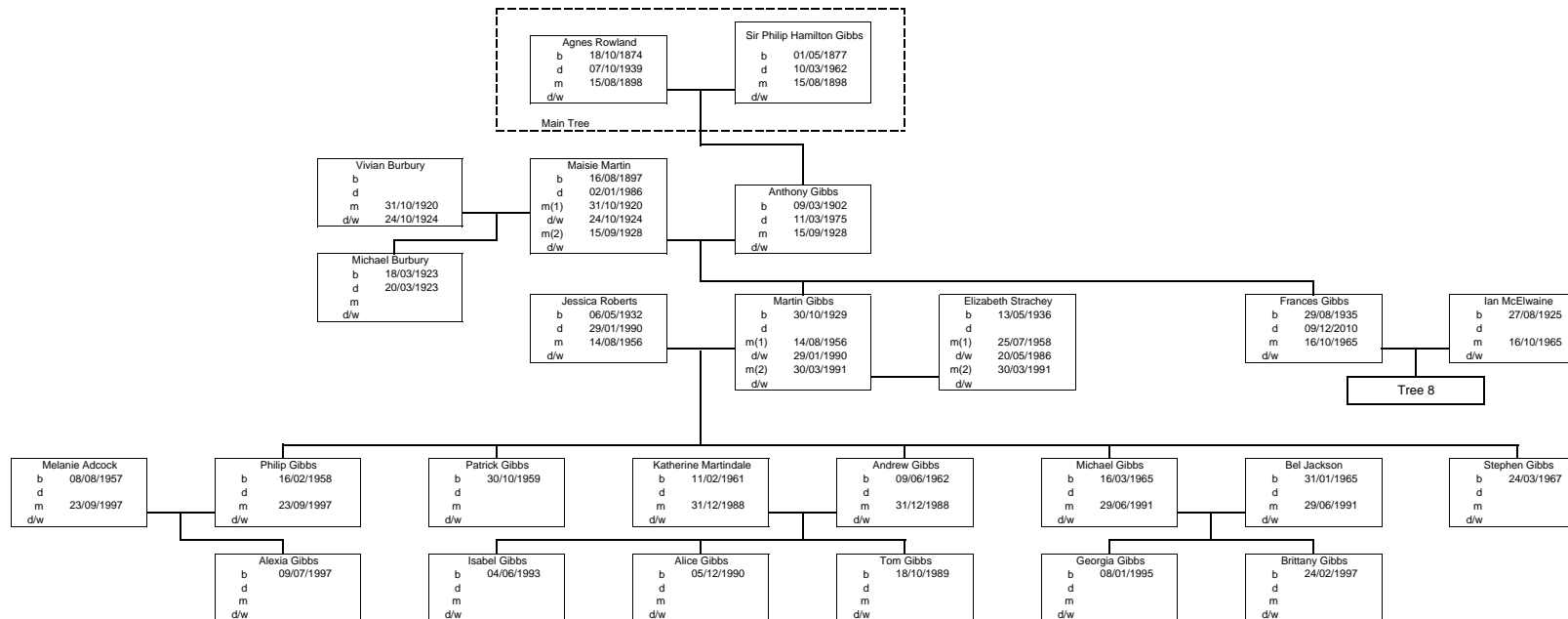

Tree 8 Gibbs Tree (cont.)

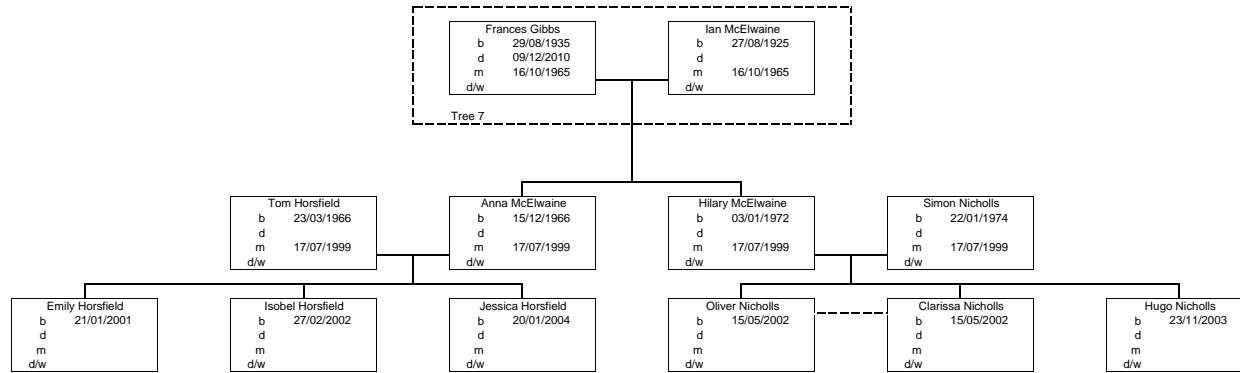

Tree 9 Sussex Connection

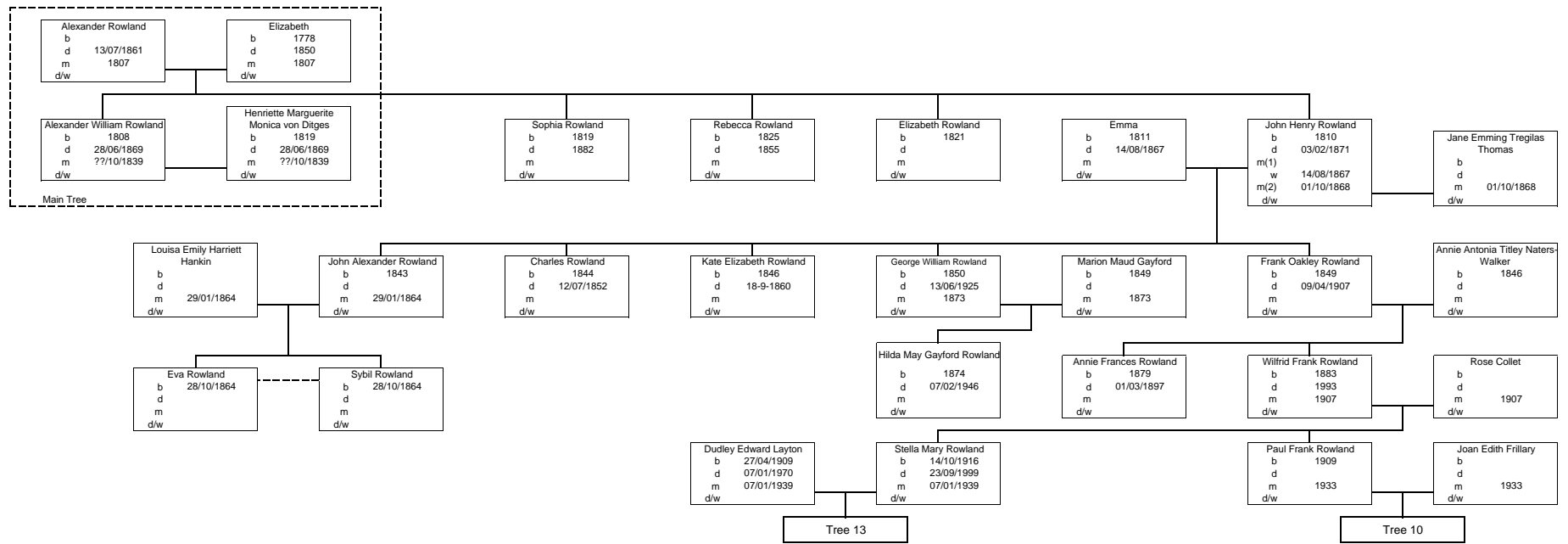

Tree 10 Sussex Connection (cont.)

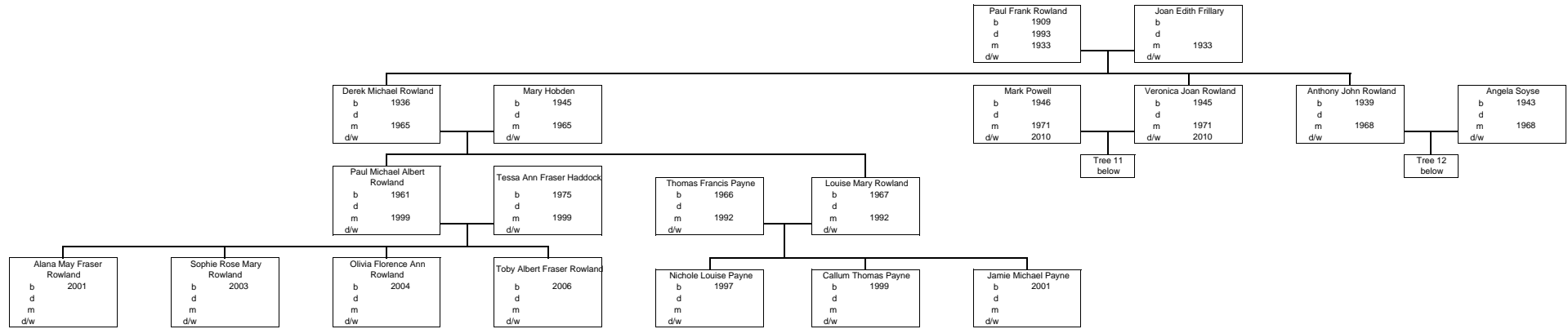

Tree 11

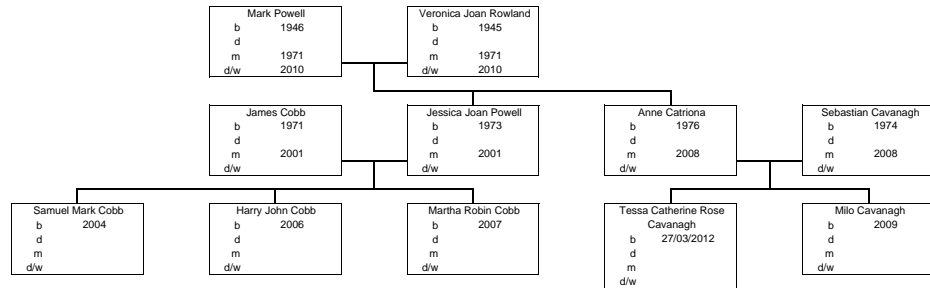

Tree 12

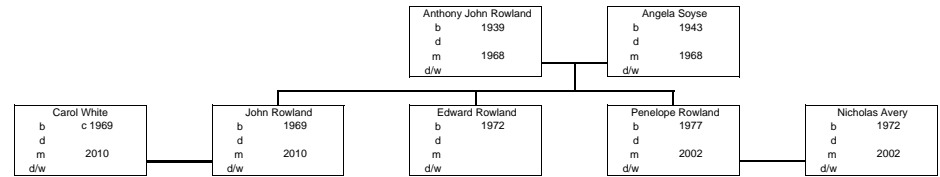

Tree 13 Layton Tree

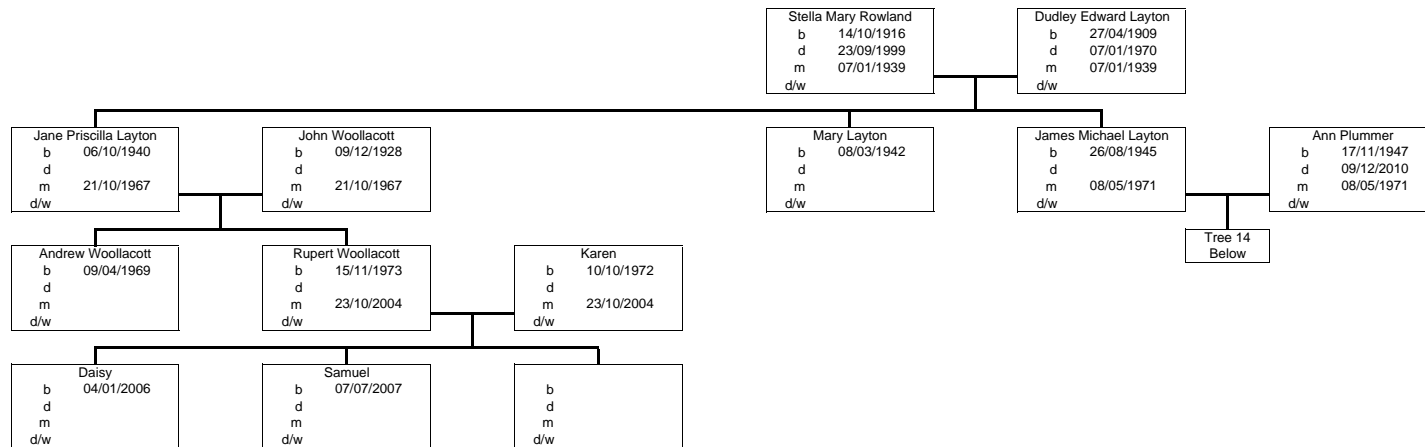

Tree 14

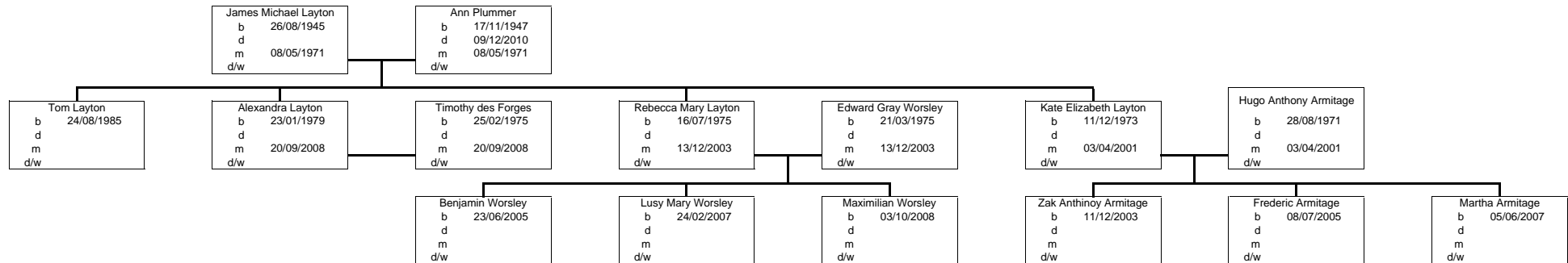

Tree 15 Mawle Tree



Tree 16 Mawle Tree (cont.)

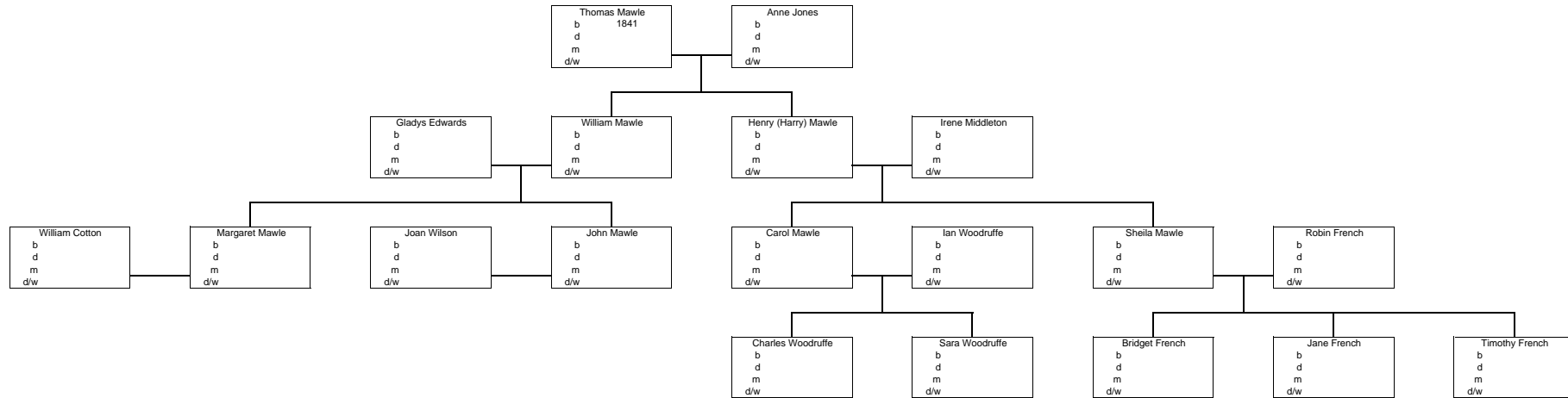

Tree 17 Cowdery Tree

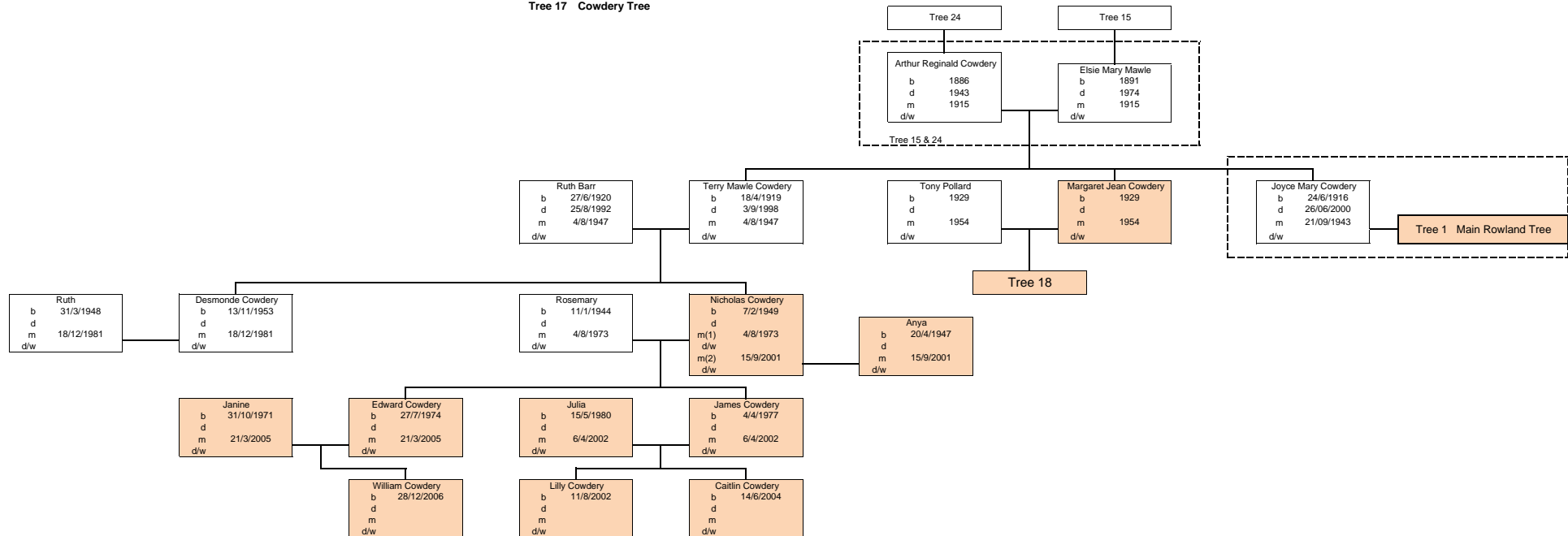

Tree 18 Pollard Tree

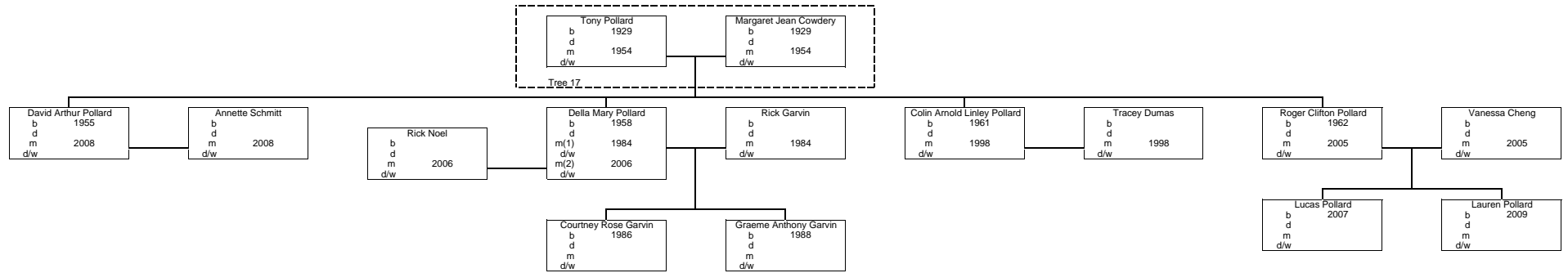

TREE 19 Mawle Tree (cont.)

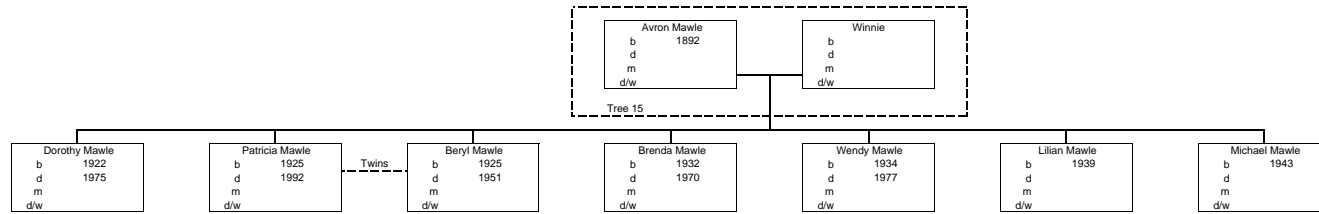

TREE 20 Mawle Tree (cont.)

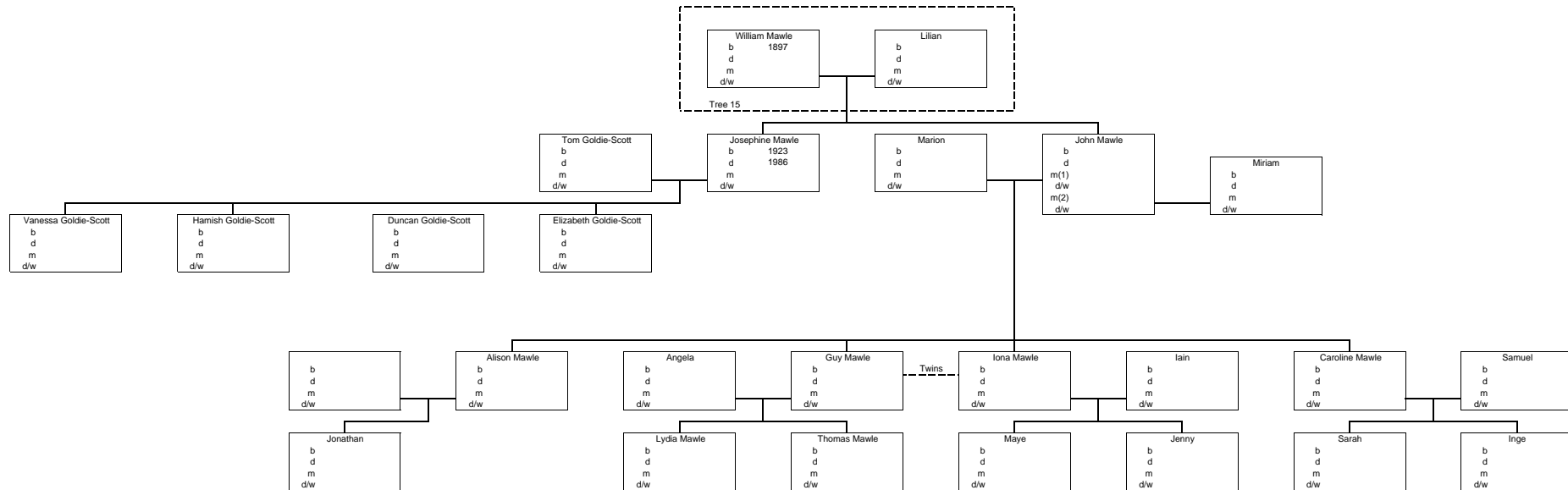

TREE 22 Mawle Tree (cont.)

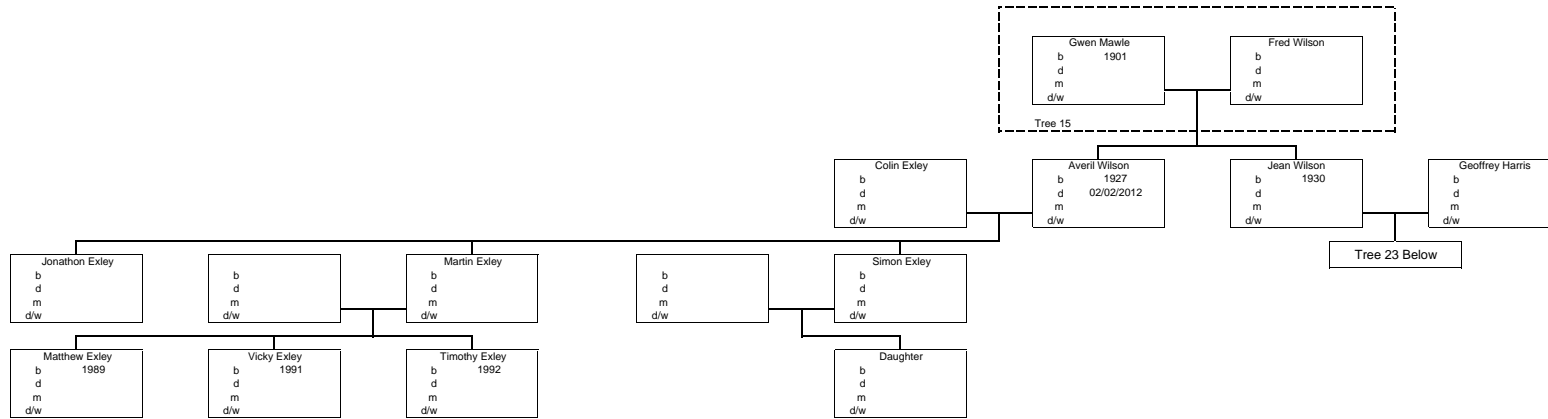

TREE 23

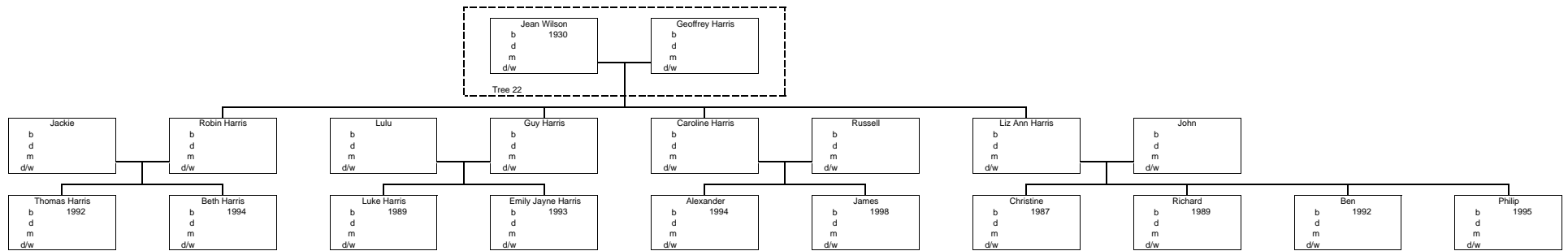

Tree 24 Cowdery Tree

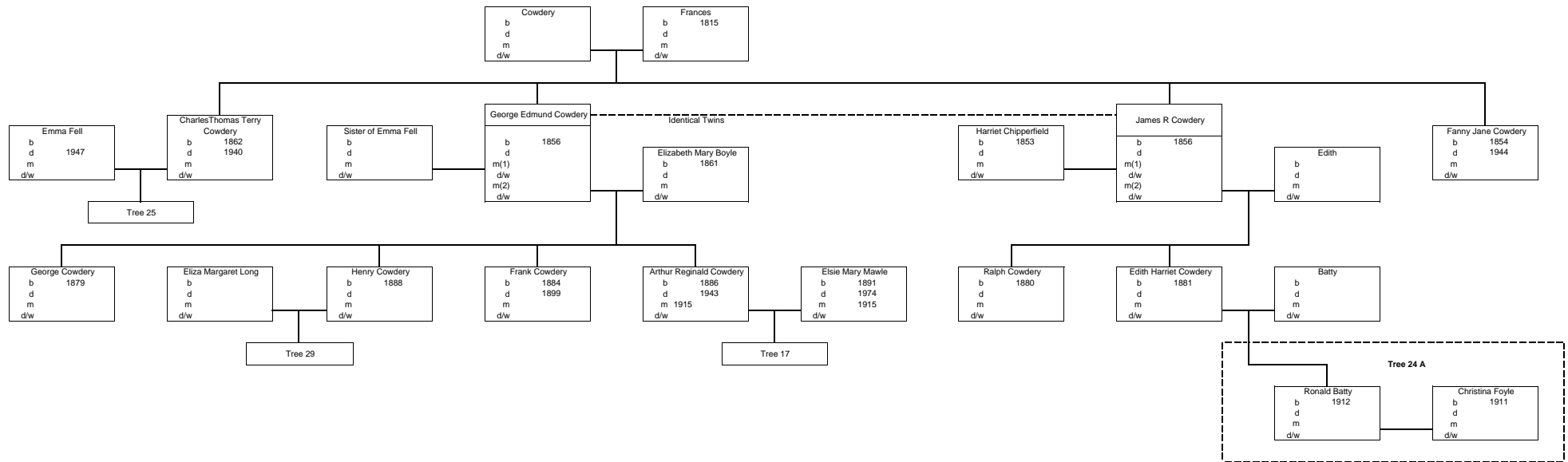

Tree 24A Foyle and Shetland Connection

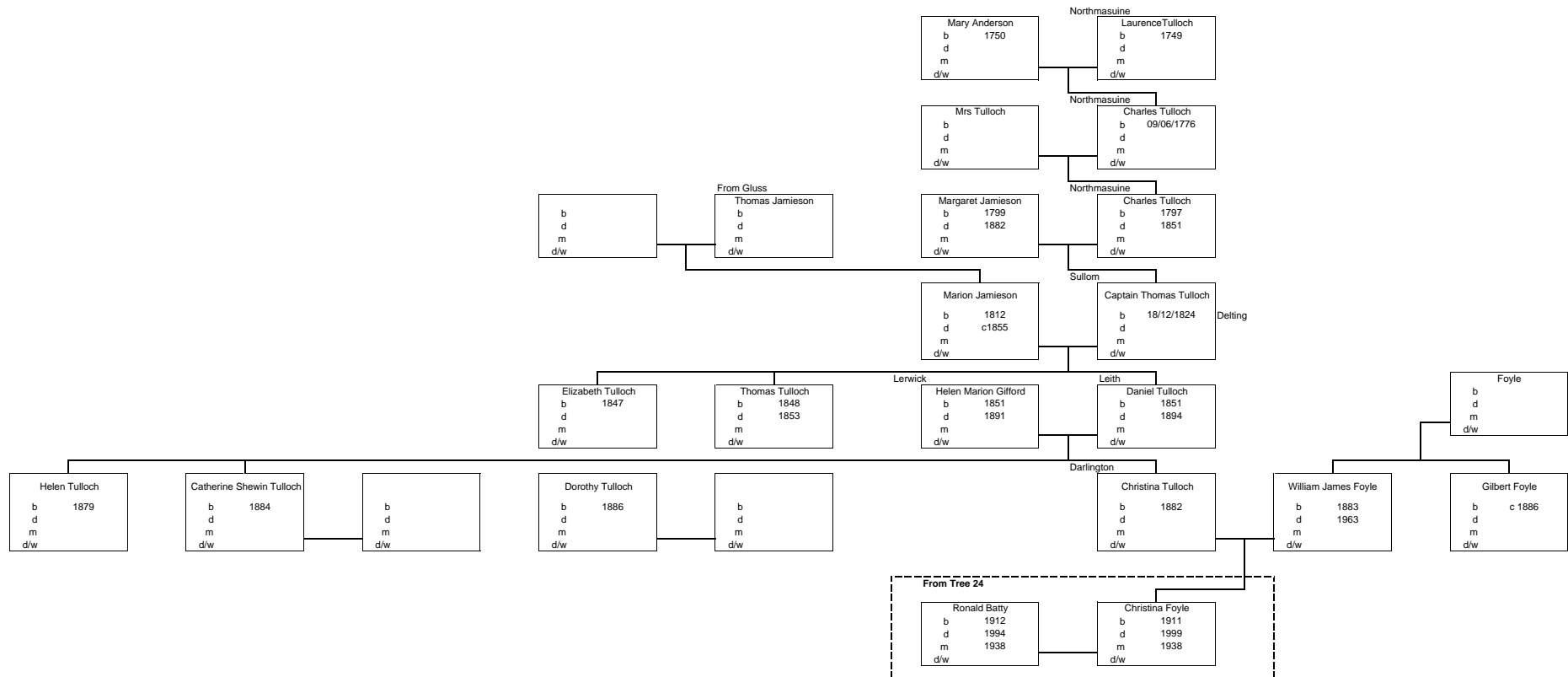

Tree 25 Cowdery Tree (cont.)

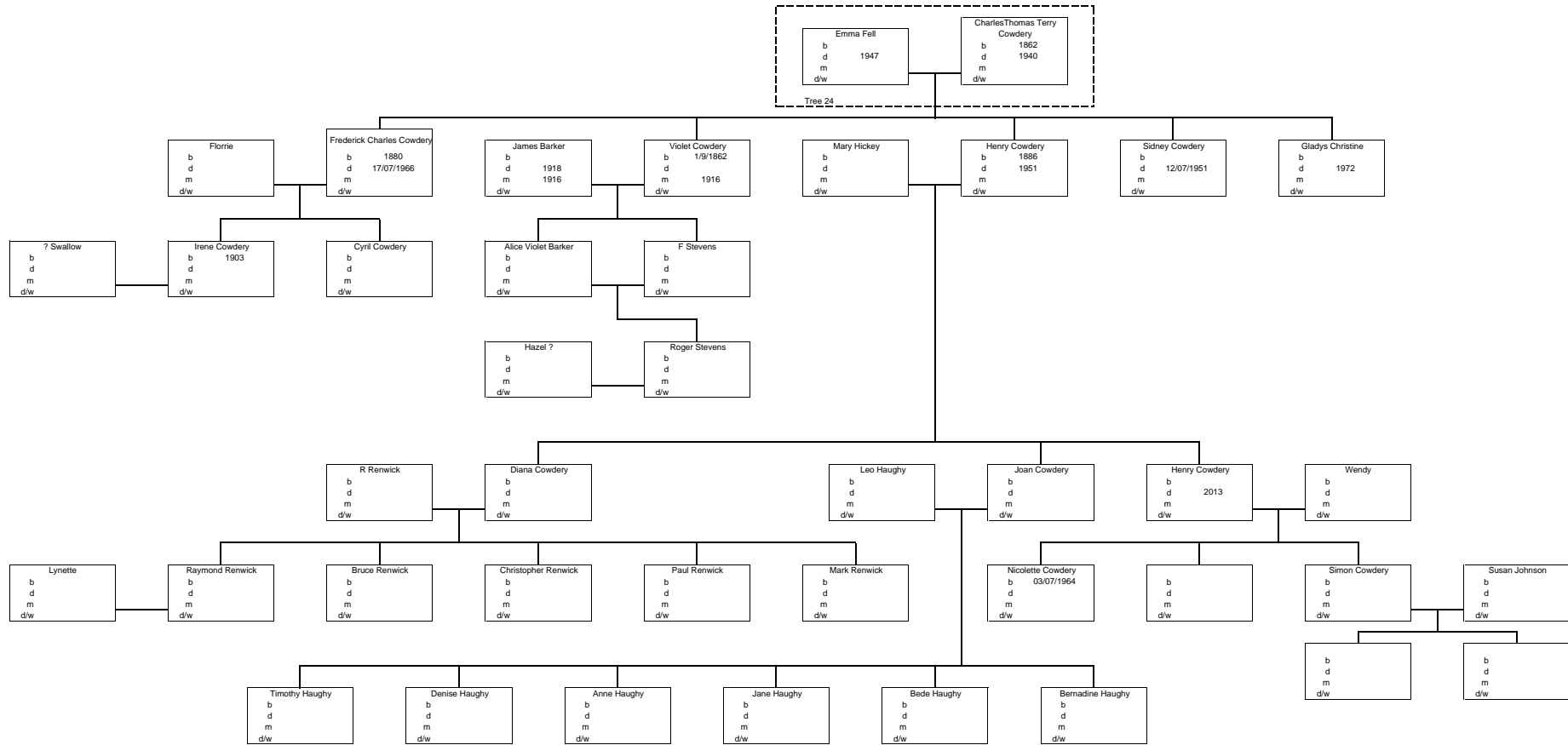

Tree 29 Cowdery Tree - Canadian Connection

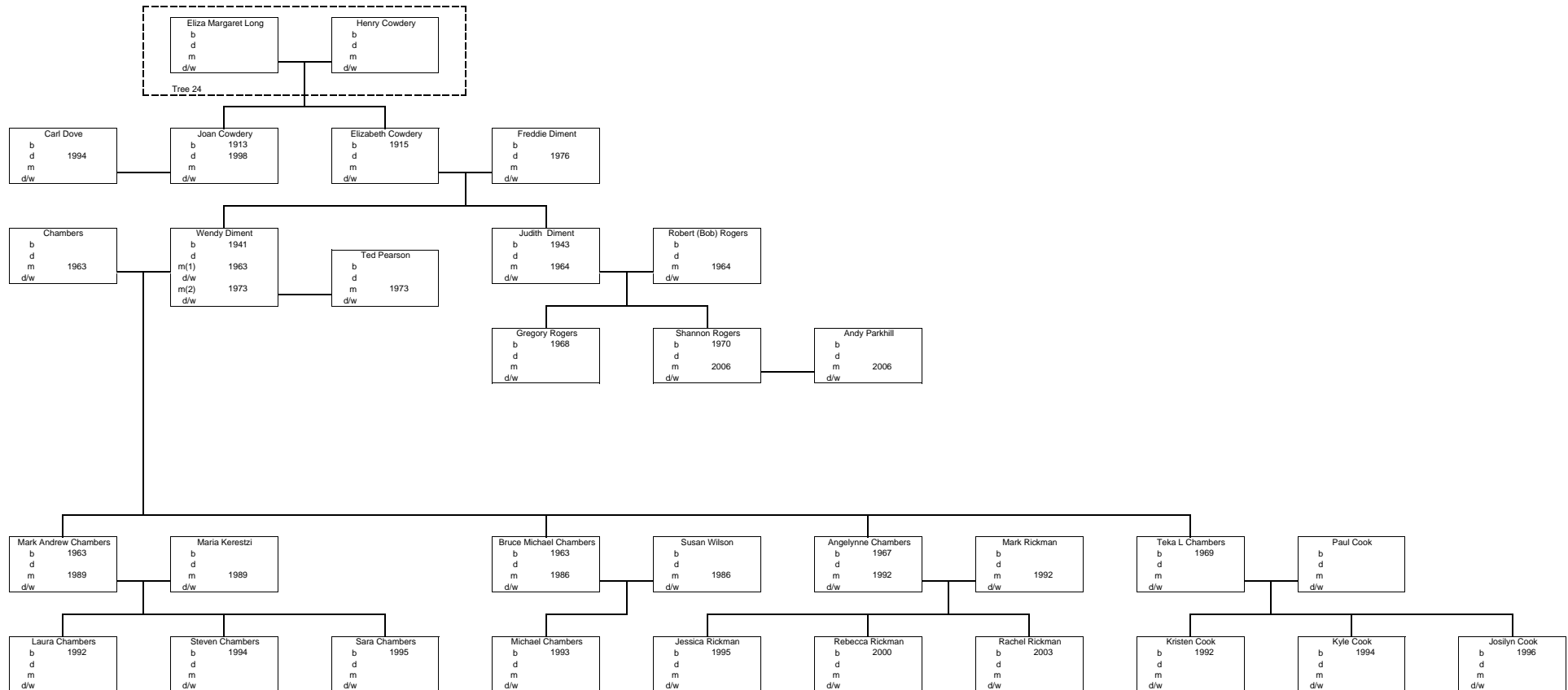

Tree 30 Adcock Tree (cont.)

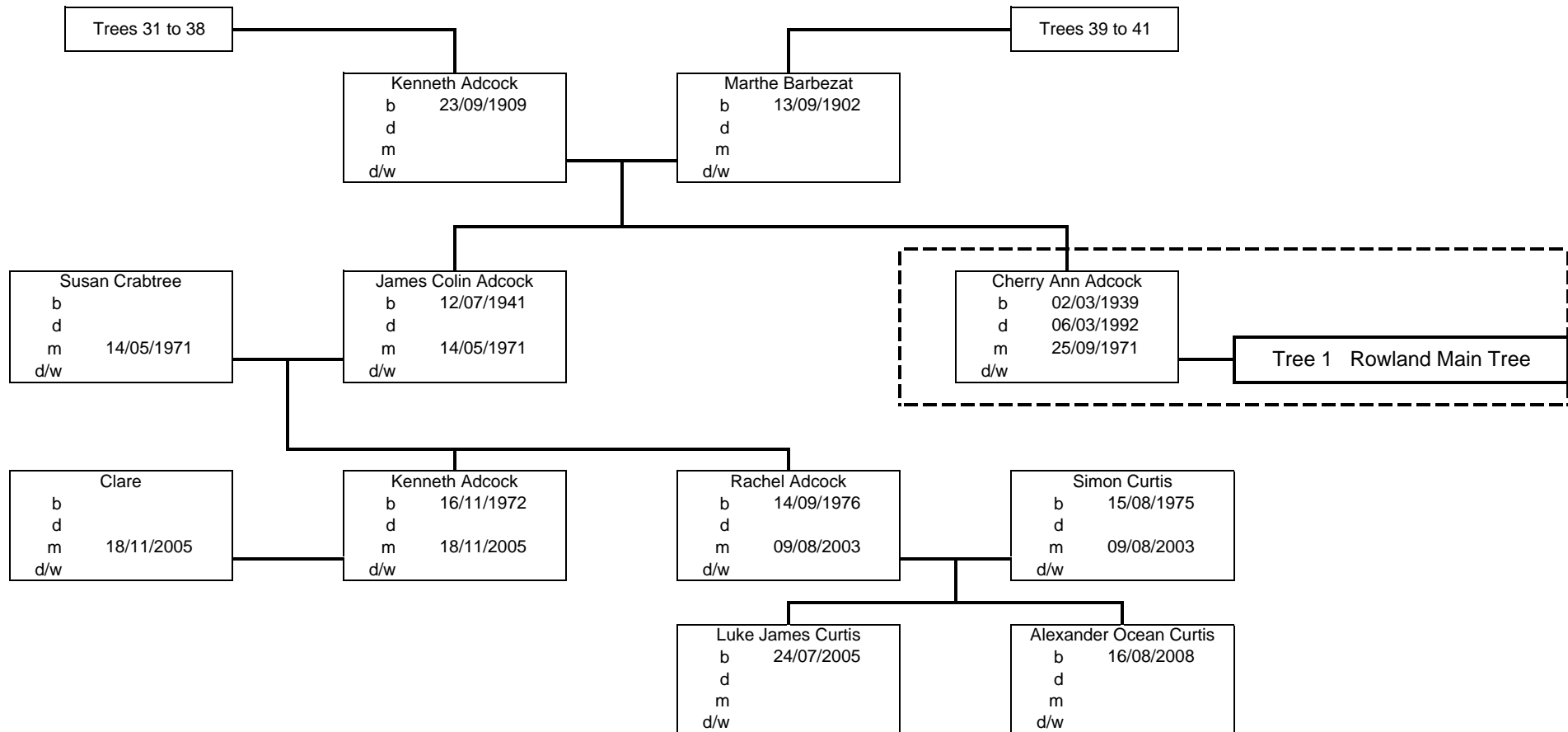

Tree 31 Adcock Tree

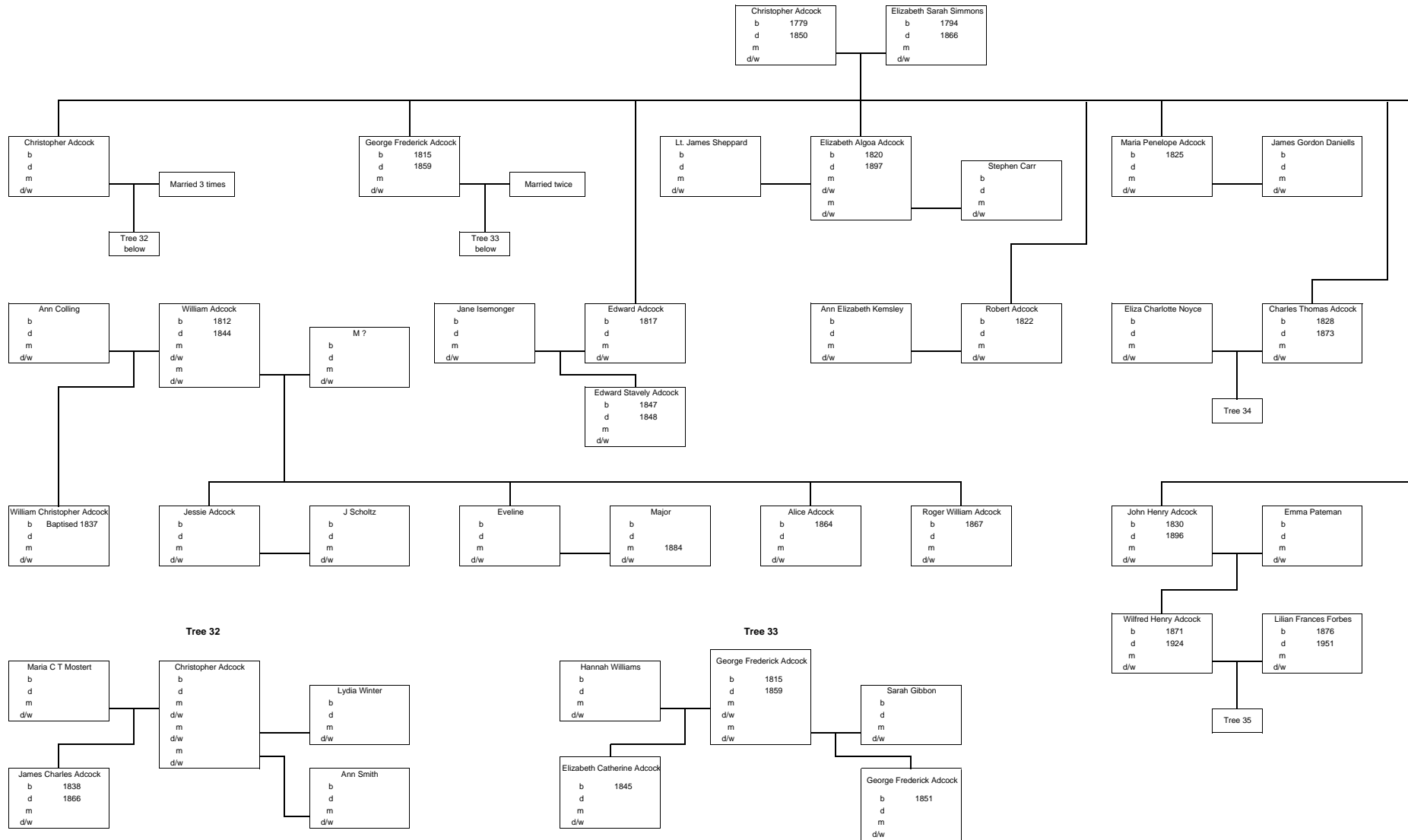

Tree 34 Adcock Tree (cont.)

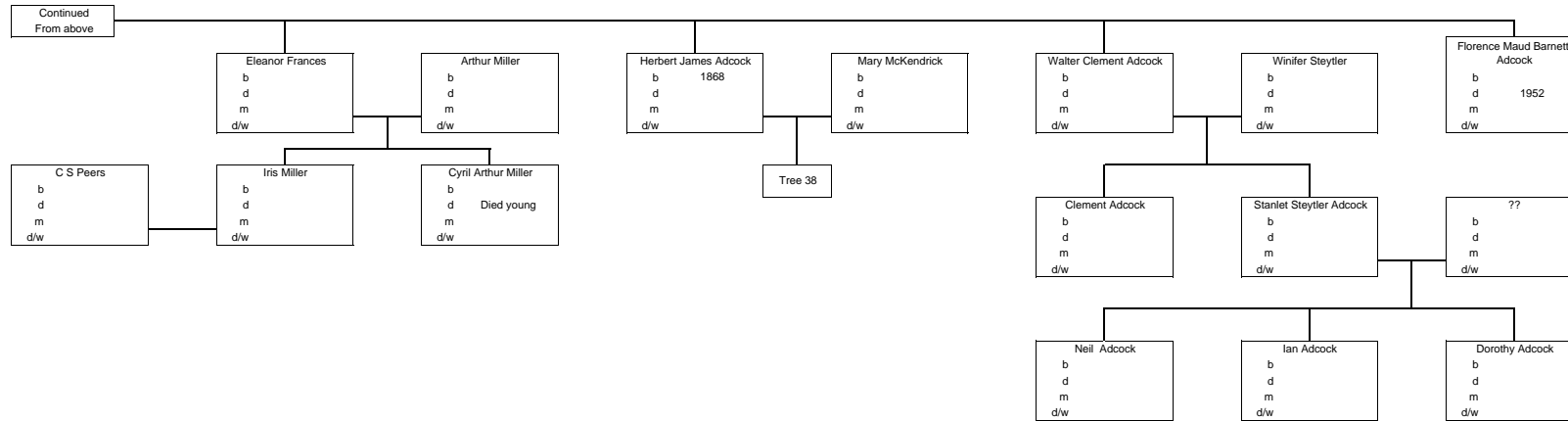
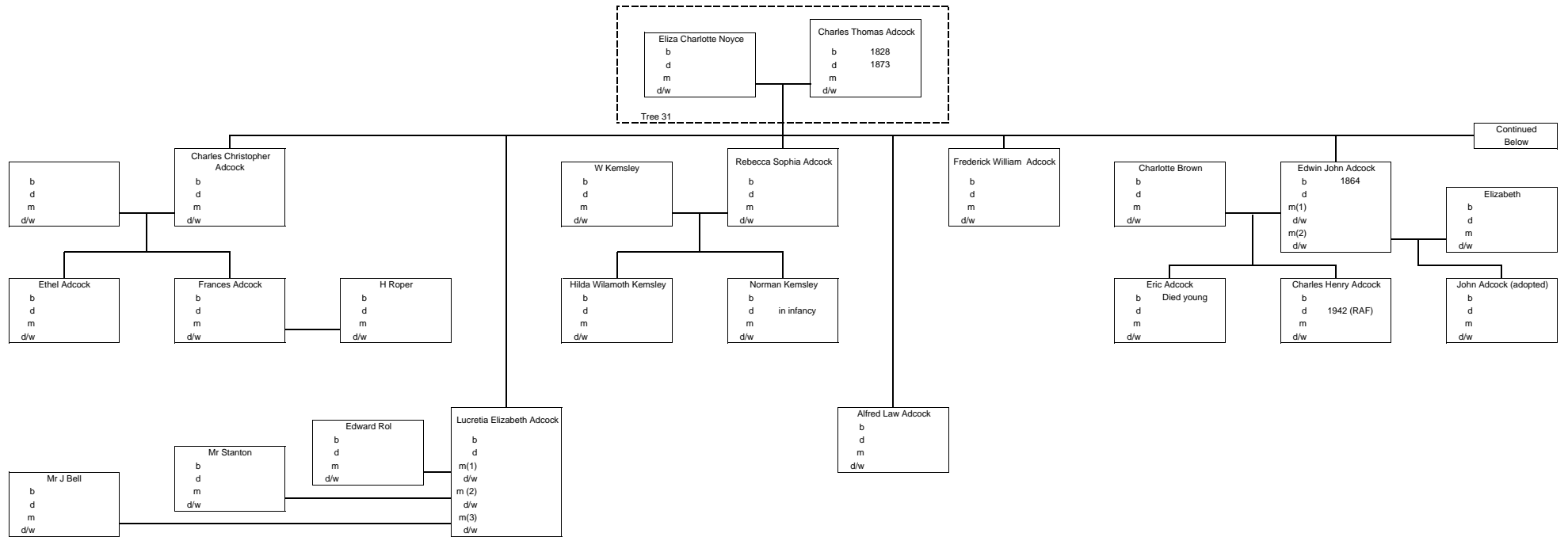

Tree 35 Adcock Tree (cont.)

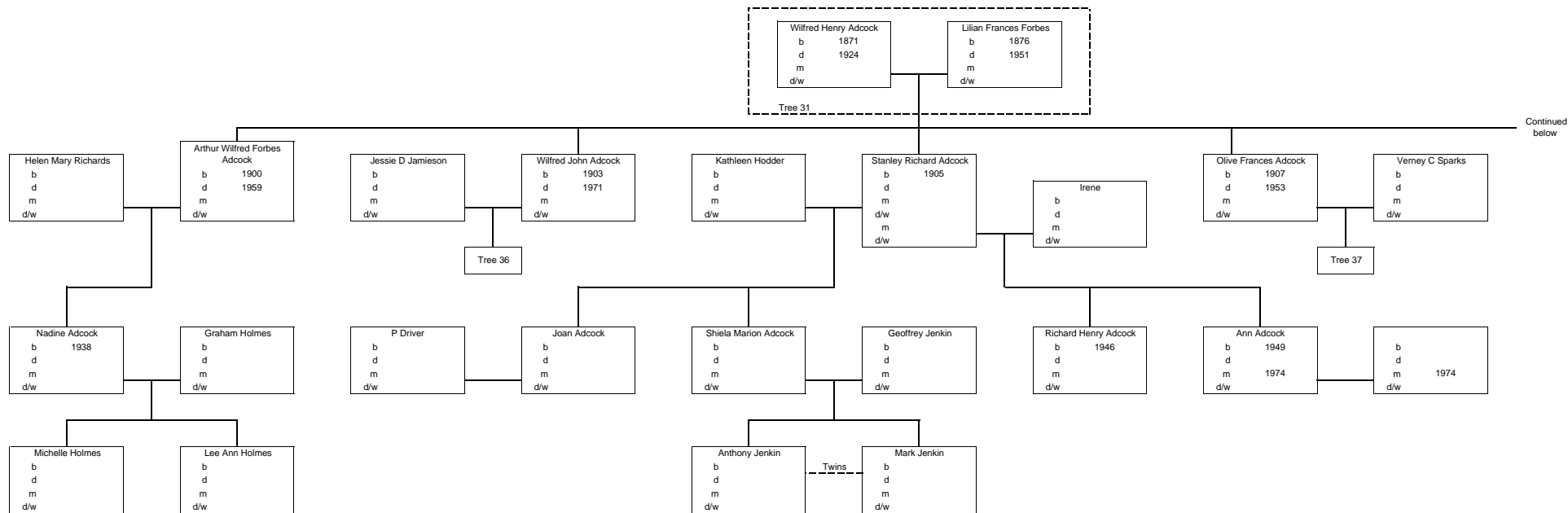

Continued below

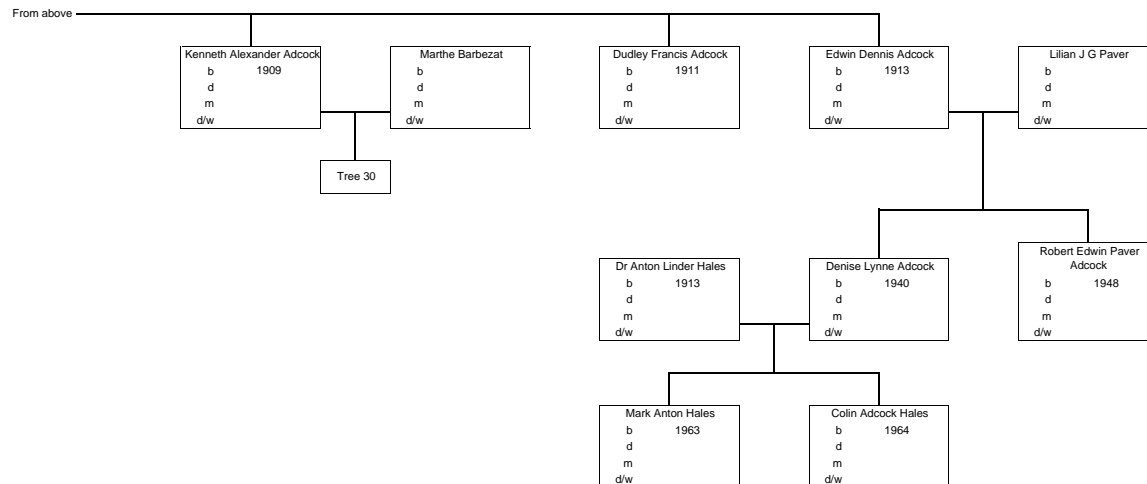

Tree 36 Adcock Tree (cont.)

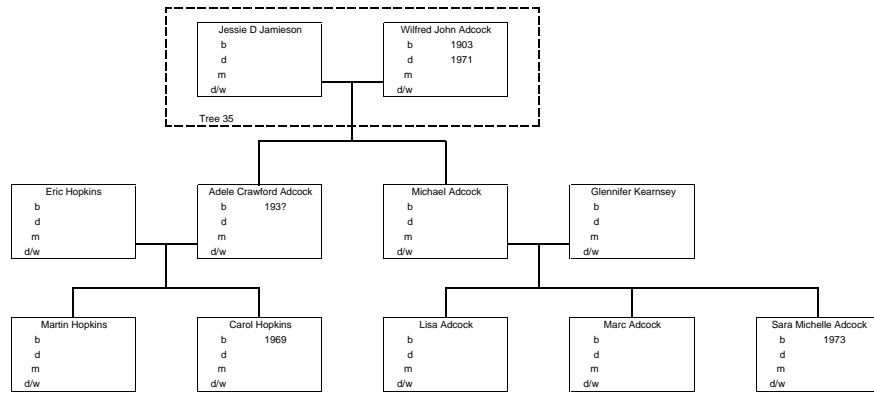

Tree 37 Adcock Tree (cont.)

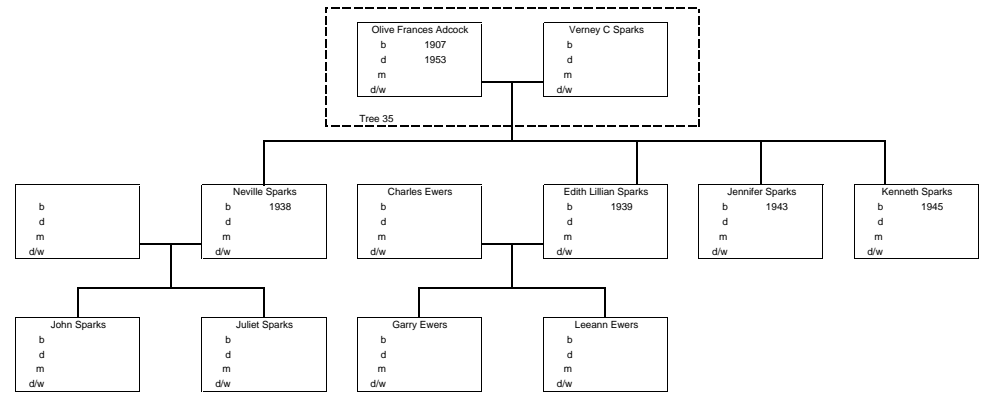

Tree 38 Adcock Tree (cont.)

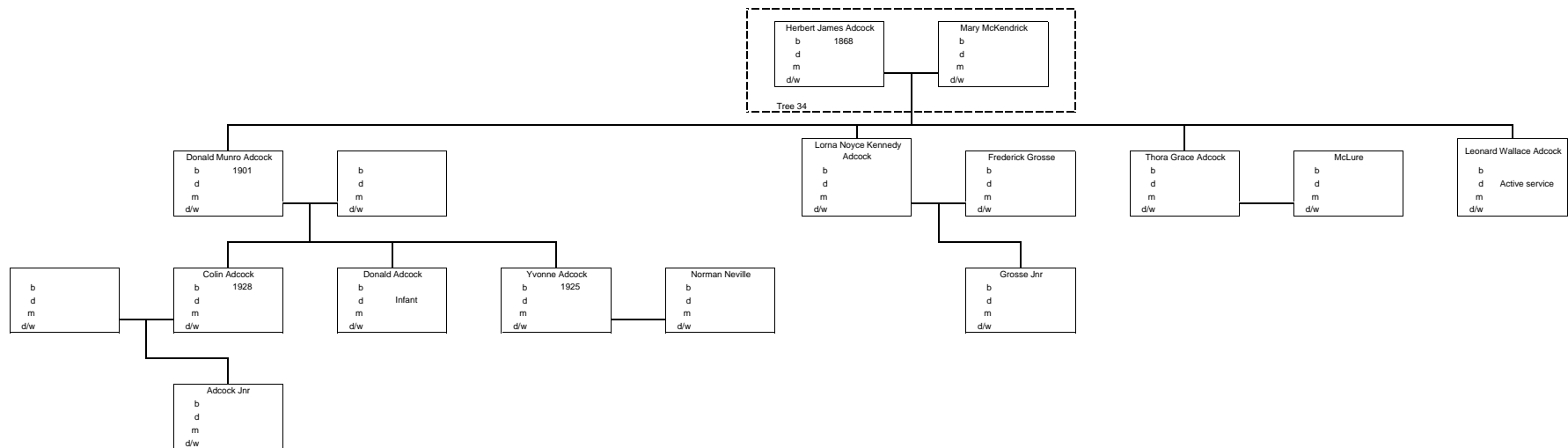

Tree 39 Barbezat Tree

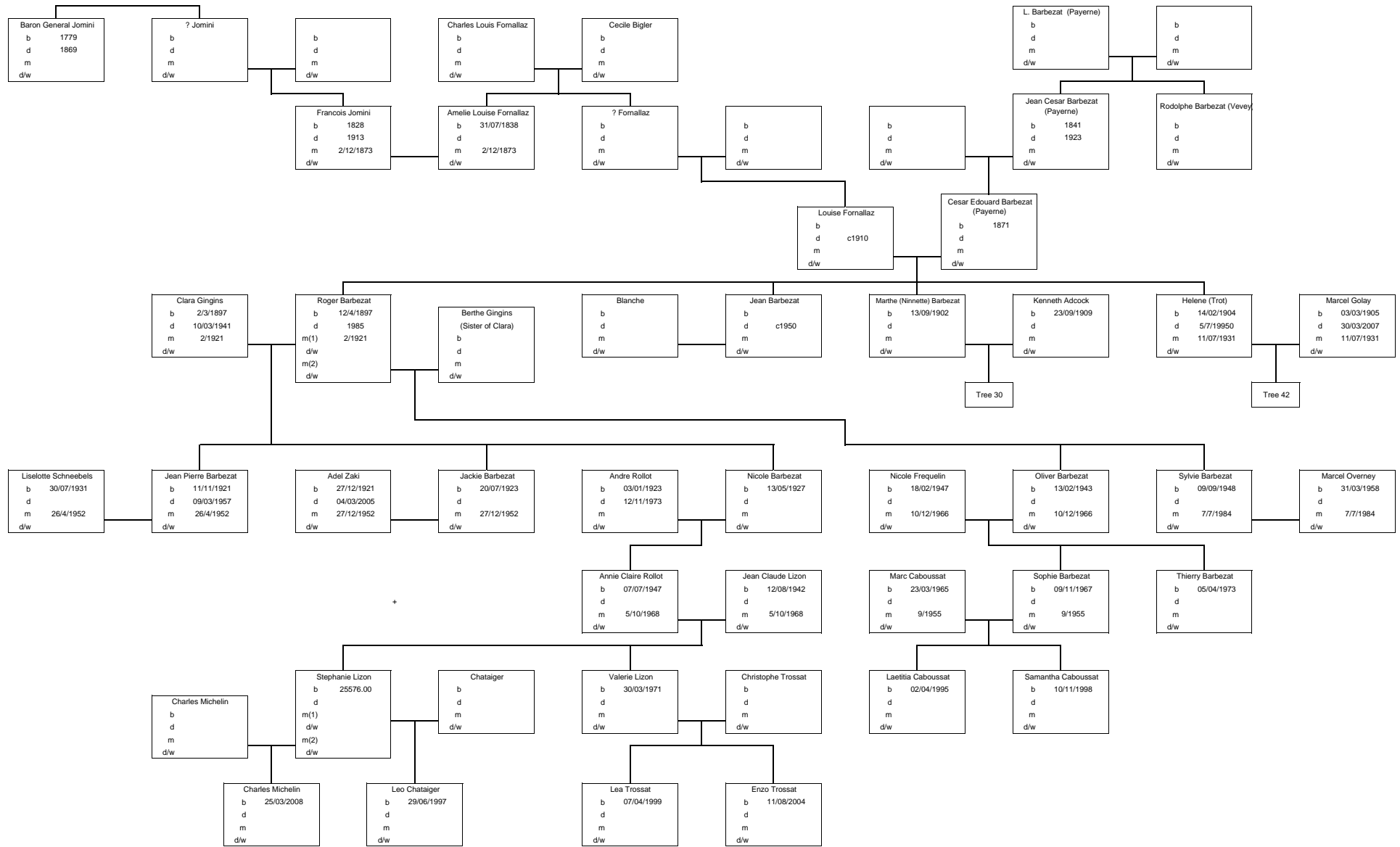

Tree 42 Barbezat Tree

